



Description:

The Series PTSR-X Push-to-Seat sealed relay holder is specifically designed to accept standard Mini ISO relays, Delphi 630 Metri-Pack terminals and 480 Metri-Pack seals. This uniquely designed sealed unit also features a Push-to-Seat connection system, that eliminates the costly and labor intensive “5 step” pull-to-seat assembly approach.

Specifications:

Base-polyester thermoplastic

Seal-silicone

TPA-nylon

Features:

- Sealed, rated at IP 66
- Labor saving “push-to-seat” connection system
- Molded in rugged polyester thermoplastic material
- Accepts any wire size, in any cavity using Delphi 630 Metri-Pack sealed push-to-seat terminals

NOTE...Requires DELPHI 480 Metri-Pack Cable Seals

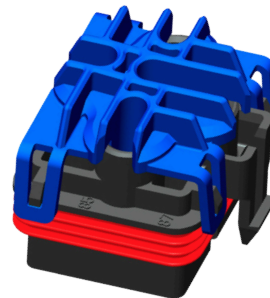
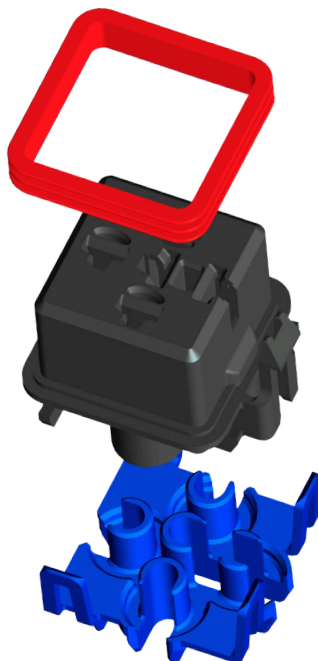
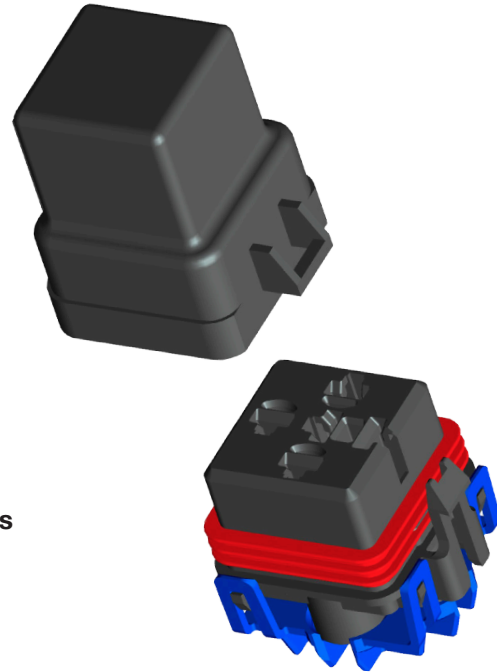

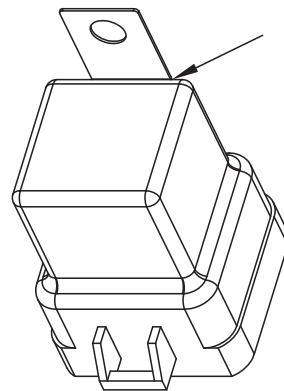
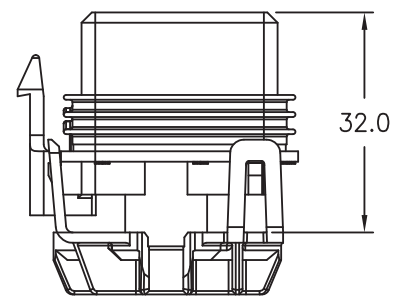
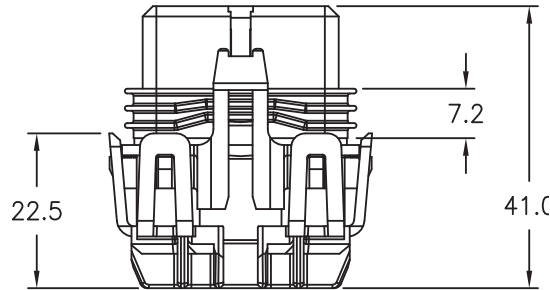
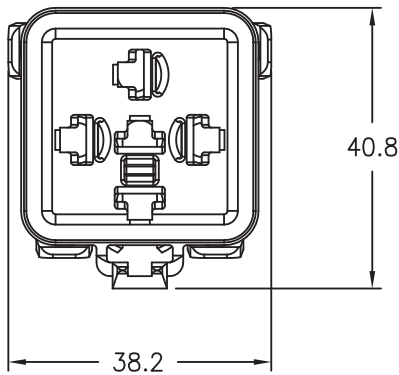

MATES TO A CUSTOMER PROVIDED MINI ISO RELAY

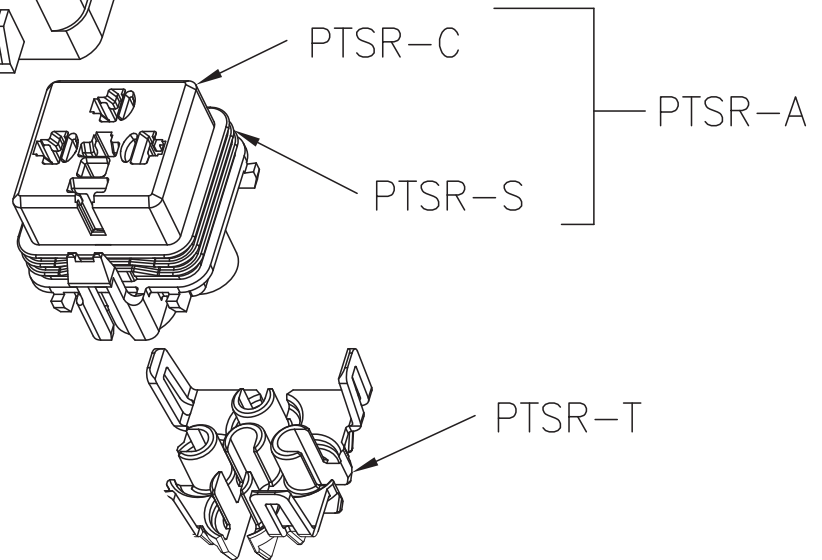
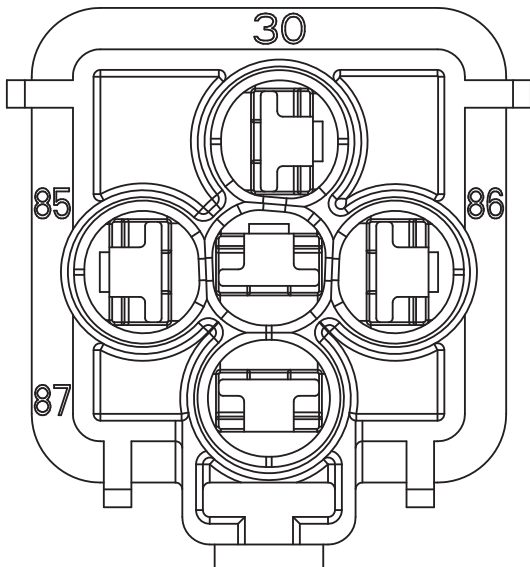

PTSR-X

OPTIONS

- A - CONNECTOR & SEAL ASSEMBLY
- C - CONNECTOR BODY
- S - CONNECTOR SEAL
- T - TPA (TERMINAL POSITION ASSURANCE)

Uncontrolled Document
Last Revision: 10.26.2020