

PROPRIETARY RIGHTS ARE CLAIMED FOR THE MATERIAL DISCLOSED IN THIS DRAWING.

TYP. WALL THICKNESS = 1.8

LTR.	REVISIONS	DATE
✳	*****	00-00-98

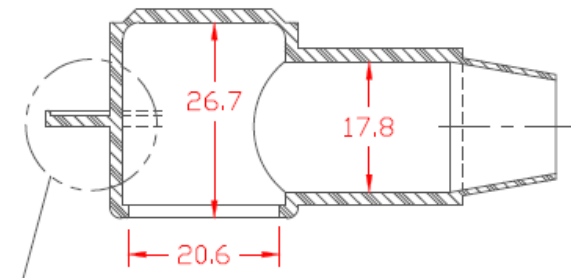

SEE VIEW "B"

SECTION A-A

SEAL NO. 3 SHOWN

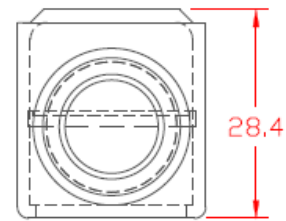

VIEW "B"
SCALE: 3" = 1"

SEAL OPTIONS
SEAL THICKNESS = .8

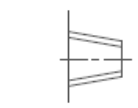

NO. 1
Wire Gages
18 - 10

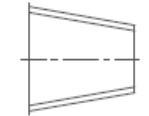

NO. 2
Cable Gages
8 - 2

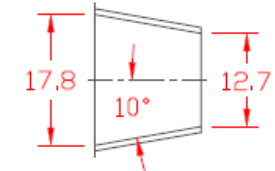

NO. 3
Cable Gages
2 - 2/0

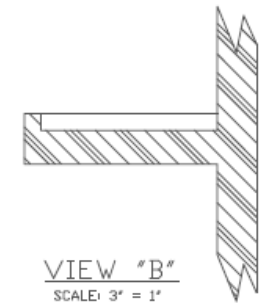
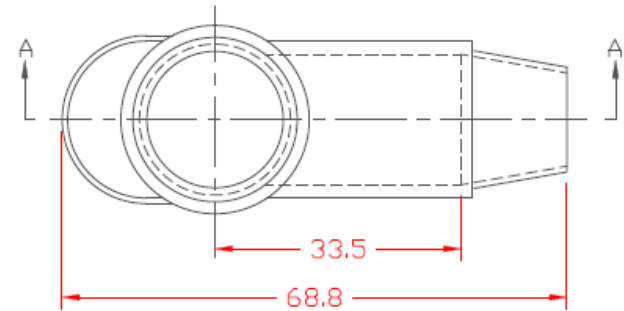

TOLERANCE UNLESS OTHERWISE SPECIFIED: ±.030"/±0.8mm
RADIAL DIAMETERS TO BE MEASURED OVER MANDRELS,
RING GAGES OR PIN GAGES OF SUITABLE SIZE

VTE Material Part No: 1101650102
 Material: RED PVC
 Material Part No: 9812-65-RED683
 Max. Operating Temp: 105 C
 Shore Durometer: "A" 10 SEC. 67/62
 Specific Gravity: 1.34
 Ult. Elongation %: 475
 Brittle Temp: -44 C
 Tensile Strength PSI: 1547 PSI

U.L. Rating: 94 V2
 MEETS: FMVSS.302





WAYTEK, INC.

REF:	DATE: 3-24-98	DRN BY: JC CHK'D BY:	WEIGHT: .022 LBS. / 9.75 G
TITLE: TERMINAL INSULATOR CAP			
MATERIAL:		PART NO: 222N3V02	
COLOR:	DRG CLASS		