

Rating	25A 12V DC		
Contact Resistance	50m ohm Max.		
Insulation Resistance	DC 500V 100M ohm Min.		
Dielectric Strength	AC 1500V 1 minute		
Operation Temperature	-20°C ~ 65°C		
Switch Function	3P SPST ON-OFF (LED)		

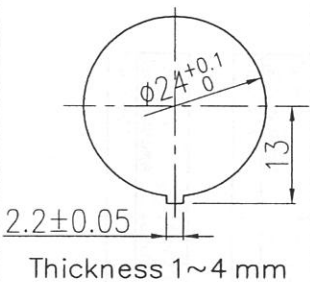

Material:  
 Frame: Nylon 66 , Black  
 Actuator: Nylon 66 +33%GF, Black  
 LED: Red

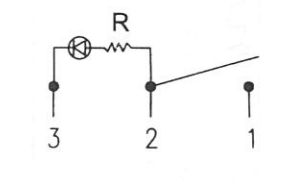
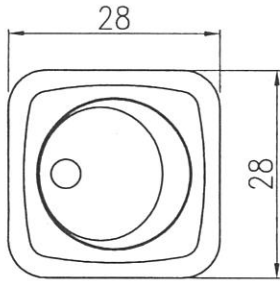
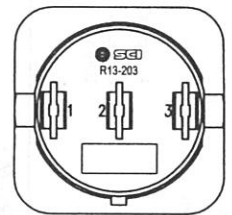
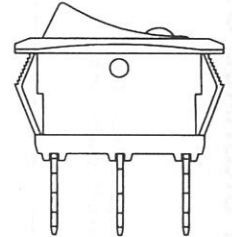
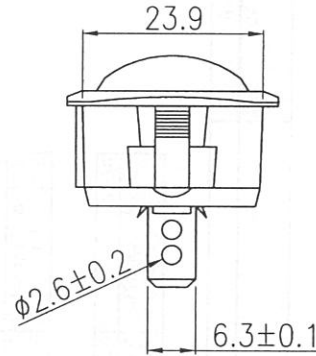
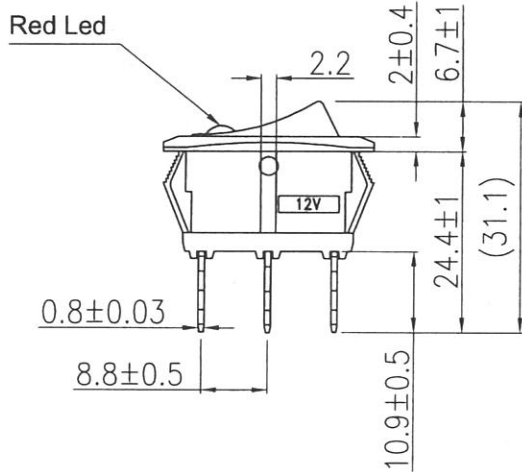

Tolerances  $\pm 0.3$  Unless Otherwise Specified

								△	
								△	
Date	Name	Description						No.	
Drawn	Checked	Approved	SCI BOM No.	1821491	Model Name	ROCKER SWITCH			
張東	<i>ABML</i>	<i>Simon</i>	Customer No.		Model No.	R13-203L-01		Rev.	
8/13/12	8/25-12	8/25-12	Unit	mm	Shin Chin Industrial Co., Ltd.			0	