



DM Dura|Mate™ Family



Environmentally-Sealed, Multi-Pin, Heavy-Duty, Plastic or Metal Circular Connectors

Amphenol Sine Systems' **Dura|Mate™ Family** of environmentally-sealed, multi-pin, heavy duty, plastic (AHDP) or metal (AHDM/AHDBM) circular connectors provide an economical, quick-connect, bayonet-locking system manufactured to withstand the challenges and complexities of harsh-environment, off-road applications. Our ISOBUS 91 Series products specifically meet ISO 11783 standards (for control and communications between tractors, implements and software) for agricultural applications. Available in the following variations: **Dura|Mate™ AHDP**, **Dura|Mate™ AHDP with Panel|Mate™**, **Dura|Mate™ AHDP with HYPERBUSS™**, **Dura|Mate™ AHDP ISOBUS 91 Series**, **Dura|Mate™ AHDM** and **Dura|Mate™ AHDM/AHDBM ISOBUS 91 Series**.

- DM Dura|Mate™ AHDP**
- DM Dura|Mate™ AHDP with Panel|Mate™**
- DM Dura|Mate™ AHDP with HYPERBUSS™**
- DM Dura|Mate™ AHDP ISOBUS 91 Series**
- DM Dura|Mate™ AHDM**
- DM Dura|Mate™ AHDM/AHDBM ISOBUS 91 Series**

Key Features

- 3 key-way bayonet design ensures proper mating of connectors
- High density signal and mixed power insert configurations
- Operating temperature range: -55°C to +125°C
- High current configurations incorporating revolutionary RADSOK® contacts
- High strength impact resistant & lightweight thermoplastic or zinc-alloy metal housings
- Low insertion force stamped terminals offer improved manufacturing efficiencies
- Environmentally-sealed and engineered rapid and secure mating system achieves up to IP69K rating (in mated condition) from ingress of dust, water, mud and other contaminants and is vibration resistant
- Sealing features consisting of durable high temperature silicone provide barrier from lubricating oils, hydraulic fluids and fossil fuels
- Wire entry sealing available in three separate ranges for discrete wire applications
- Backshells maintain a compression-fit design to resist maximum pull-out forces and facilitate strain-relief for jacketed cable ranges
- Smooth Ring Adapters (SRA) are designed for use without backshells for a smaller footprint
- Small Thread Adapters (STA) provide an enhanced "step down" threading for use with screw-on or clamshell backshells
- Wide Thread Adapters (WTA) provide an enhanced threading for use with our wide variety of screw-on or clamshell backshells
- Backshell Ring Adapters (BRA) allow for use with other compatible industry-standard snap-on backshells
- Utilizes A Series™ standard contact system (Stamped & Formed or Machined)



Standard products. Custom solutions
Customer Service +1 800 394 7732

DuraMate™ AHDP/AHDM Series - Part Numbering Sequence

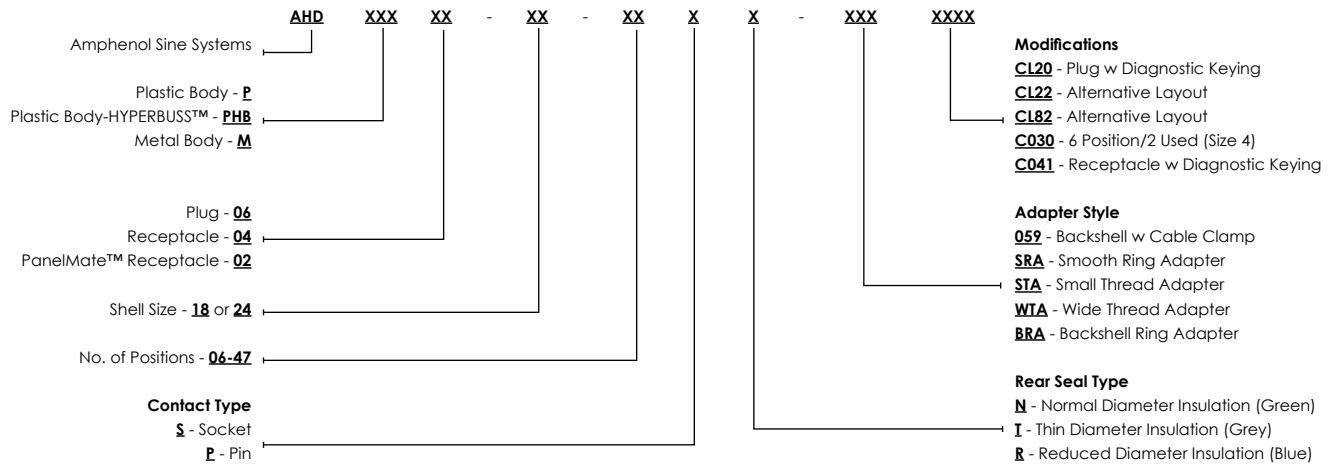

DuraMate™ AHDP and AHDM Series - Variations



AHDP04-18-06PN-BRA

Shell Size 18, 6 Position, Receptacle, Pin, DuraMate™ AHDP, Plastic, Normal Seal, Backshell Ring Adapter (BRA)



AHDP06-18-20SN-SRA

Shell Size 18, 20 Pos, Plug, Socket, DuraMate™ AHDP Series, Plastic, Normal Seal, Smooth Ring Adapter (SRA)



AHDP04-24-27SR-STA

Shell Size 24, 27 Pos, Receptacle, Pin, DuraMate™ AHDP, Plastic, Normal Diameter Seal, Small Thread Adapter (STA)



AHDP02-18-08PR-WTA

Shell Size 18, 8 Pos, Receptacle with Flange, Pin, DuraMate™ AHDP with PanelMate™, Plastic, Reduced Seal, Wide Thread Adapter (WTA)



AHDPH04-24-16P-BLK/RED

Shell Size 24, 16 Position, Receptacle, Size 12 Contacts, (1) 16 Pin (400A), DuraMate™ AHDP with HYPERBUSSTM, Plastic, Potted, Black or Red Body (Includes bolt, nut and washers)



AHDM04-18-08SN

Shell Size 18, 8 Pos, Receptacle, Socket, DuraMate™ AHDM Series, Metal Body, Normal Seal, Wide Thread Adapter (WTA)



AHDM06-24-16PR

Shell Size 18, 16 Pos, Plug, Pin, DuraMate™ AHDM Series, Metal Body, Reduced Seal, Wide Thread Adapter





DM DuraMate™ AHDP

Environmentally-Sealed, Multi-Pin, Heavy-Duty, Plastic, Circular Connectors



Available in Shell Size 18 with 8 insert arrangements 2, 6, 8, 14(x3), 20 and 21

Available in Shell Size 24 with 16 insert arrangements 7(x2), 9, 14, 16, 18(x2), 19, 21, 23, 27, 29, 31, 33, 35 and 47

Amphenol Sine Systems' DuraMate™ AHDP connectors are an environmentally-sealed, multi-pin, heavy duty, plastic, circular connector with IP68 and IP69K ratings (in mated condition) that contains an economical, quick-connect, bayonet locking system manufactured to withstand the challenges and complexities of harsh environment off-road applications. Available in the following options: DuraMate™ AHDP with PanelMate™ and DuraMate™ AHDP with HYPERBUSS™.



Key Features

- 3 keyway bayonet design ensures proper mating of connectors
- High density signal and mixed power insert configurations
- High current configurations incorporating revolutionary RADSOK® contacts
- Low insertion force stamped terminals offer improved manufacturing efficiencies
- Sealing features consisting of durable high temperature silicone provide barrier from lubricating oils, hydraulic fluids and fossil fuels
- Backshells maintain a compression-fit design to resist maximum pull-out forces and facilitate strain-relief for jacketed cable ranges.
- Wire entry sealing available in four separate ranges for discrete wire applications
- Environmentally-sealed and engineered rapid and secure mating system achieves up to IP69K rating (in mated condition) from ingress of dust, water, mud and other contaminants and is vibration resistant
- Smooth Ring Adapters (SRA) are designed for use without backshells for a smaller footprint
- Small Thread Adapters (STA) provide an enhanced "step down" threading for use with screw-on or clamshell backshells
- Wide Thread Adapters (WTA) provide an enhanced threading for use with our wide variety of screw-on or clamshell backshells
- Backshell Ring Adapters (BRA) allow for use with other compatible industry-standard snap-on backshells
- Utilizes A Series™ standard contact system (Stamped & Formed or Machined)



DuraMate™ AHDP - Specifications (Reference Individual Datasheets)

Current Rating per Contact	Size 4 - 100A / Size 4+ - 100A Size 8 - 60A / Size 8 RADSOK - 80A Size 12 - 25A Size 16 - 13A Size 20 - 7.5A
Operating Temperature	-55°C to +125°C
Dielectric Withstanding Voltage	Current Leakage -2mA at 1500 VAC
IP Rating (in mated condition)	IP68 and IP69K
Mating Cycle Durability	100 Cycles

Housing Material	Thermoplastic
Insulation Insert	Thermoplastic
Seal	Silicone Rubber
Contact	A Series™ Common System
RoHS Compliant	ALL materials meet the requirements of the European Directive. (See website for documentation)



Standard products. Custom solutions
Customer Service +1 800 394 7732

DuraMate™ AHDP - Insert Arrangements (1) C030 - 6 Pos/2 Used (Size 4); (2) C041 - Recep w Diagnostic Keying; (3) CL20 - Plug w Diagnostic Keying; (4) CL22 - Alternative Layout; (5) CL82 - Alternative Layout

Shell Size 18							
18-06 (1) 2 x Size 4	18-06 2 x Size 4, 4 x Size 16	18-08 8 x Size 12	18-14 14 x Size 16	18-14 (2) 14 x Size 16	18-14 (3) 14 x Size 16	18-20 2 x Size 16, 18 x Size 20	18-21 21 x Size 20
N	N	N	R	N	R	N	R

Shell Size 24									
24-07 1 x Size 8 (RADSOK®) 6 x Size 12	24-07 (4) 3 x Size 4, 4 x Size 16	24-09 1 x Size 4, 2 x Size 8 6 x Size 12	24-14 1 x Size 4, 1 x Size 12 12 x Size 16	24-16 16 x Size 12	24-18 1 x Size 8, 3 x Size 12 14 x Size 16	24-18 (5) 2 x Size 8, 16 x Size 16	24-19 6 x Size 12, 13 x Size 16	24-21 4 x Size 12, 17 x Size 16	24-23 23 x Size 16
N	N	N	R	N	R	N	R	N	R

Shell Size 24					
24-27 4 x Size 12, 23 x Size 16	24-29 4 x Size 12, 19 x Size 16 6 x Size 20	24-31 31 x Size 16	24-33 33 x Size 20	24-35 3 x Size 16, 32 x Size 20	24-47 5 x Size 16, 42 x Size 20
R	R	R	T	N	R

Contact Legend (Size/Amp)					
Size 4 or 4+ 100A	Size 8 60A	Size 8 RADSOK® 80A	Size 12 25A	Size 16 13A	Size 20 7.5A

DuraMate™ AHDP - Recommended Wire Insulation Overall Diameter (OD) 4+ contact is only available for 24-07CL22

Contact Size	Typical Wire Range	(N) Normal Seal	(T) Thin Seal	(R) Reduced Seal (See datasheets)	
4+	4AWG (25.0-21.0mm²)	7.9-10.67mm (0.311-0.420")	-	-	-
4	6AWG (16.0-13.0mm²)	6.63-7.41mm (0.261-0.292")	-	6.63-7.41mm (0.261-0.292")	-
8	8-10AWG (10.0-5.0mm²)	4.83-6.10mm (0.190-0.240")	-	3.43-5.59mm (0.135-0.220")	-
12	10-14AWG (6.0-2.0mm²)	3.43-4.32mm (0.1350-.170")	-	2.46-4.01mm (0.135-0.158")	2.46-4.01mm (0.135-0.158")
16	14-20AWG (2.0-0.5mm²)	2.54-3.40mm (0.100-0.134")	2.23-2.69mm (0.088-.106")	1.35-3.05mm(0.053-0.120")	1.35-2.62mm (0.053-0.103")
20	16-22AWG (1.5-0.35mm²)	1.02-2.41mm (0.040-.095")	-	1.02-02.41mm (0.040-0.095")	1.02-2.10mm (0.040-0.083")

DuraMate™ AHDP - Backshell Options and Accessory Overview

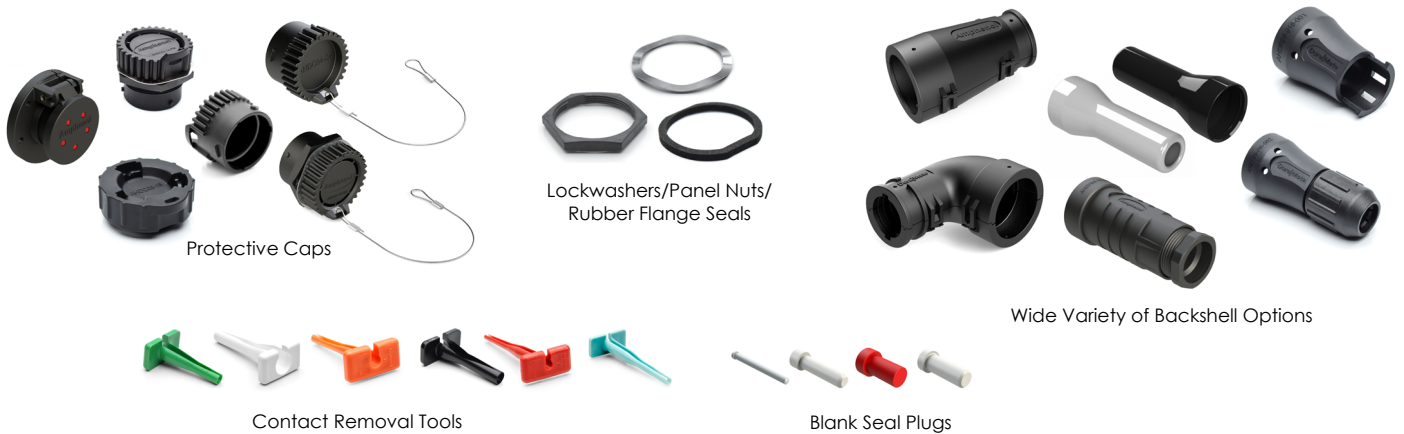

DuraMate™ AHDP - Plug & Receptacle Options (Dimensions in mm)

Shell Size 18 Plug	Shell Size 18 Receptacle
Backshell Ring Adapter (BRA) 	Backshell Ring Adapter (BRA)
Smooth Ring Adapter (SRA) 	Smooth Ring Adapter (SRA)
-	-
Wide Thread Adapter (WTA) 	Wide Thread Adapter (WTA)

Shell Size 24 Plug	Shell Size 24 Receptacle
Backshell Ring Adapter (BRA) 	Backshell Ring Adapter (BRA)
Smooth Ring Adapter (SRA) 	Smooth Ring Adapter (SRA)
Small Thread Adapter (STA) 	Small Thread Adapter (STA)
Wide Thread Adapter (WTA) 	Wide Thread Adapter (WTA)

DuraMate™ AHDP with PanelMate™ - Receptacle Options (Dimensions in mm)

	Shell Size 18 Receptacle
-	PanelMate™ with Backshell Ring Adapter (BRA)
-	PanelMate™ with Smooth Ring Adapter (SRA)
-	-
-	PanelMate™ with Wide Thread Adapter (WTA)

	Shell Size 24 Receptacle
-	PanelMate™ with Backshell Ring Adapter (BRA)
-	PanelMate™ with Smooth Ring Adapter (SRA)
-	PanelMate™ with Wide Thread Adapter (STA)
-	PanelMate™ with Wide Thread Adapter (WTA)

DuraMate™ AHDP with HYPERBUS™ - Receptacle Option (Dimensions in mm)

*For more information, refer to [HYPERBUS™ Family Literature](#)

-	-
-	-

	Shell Size 24 Receptacle
-	HYPERBUS™ (Ground/Positive)
-	-

DuraMate™ AHDP - Backshell Options and Accessories













Image	Part Number	Description
	AHDPBS-015-1805	Shell Size 18, Backshell, Conduit, Snap Over, Right Angle 90°, Duramate™ AHDP Note: For use with Wide Thread Adapter (WTA). May also be used on DuraMate™ AHDM with P/N AHDM-BS-18NUT Adapter
	AHDPBS-15L017-1805	Shell Size 18, Backshell, Conduit, Snap-Over, Right Angle 180°, Duramate™ AHDP Note: For use with Backshell Ring Adapter (BRA)
	AHDPBS-011-2405	Shell Size 24, Backshell, Conduit, Snap Over, Right Angle 90°, Duramate™ AHDP Note: For use with Wide Thread Adapter (WTA). May also be used on DuraMate™ AHDM with P/N AHDM-BS-24NUT Adapter
	AHDPBS-11L017-2405	Shell Size 24, Backshell, Conduit, Snap-Over, Right Angle 180°, Duramate™ AHDP Note: For use with Backshell Ring Adapter (BRA) and Small Thread Adapter (STA)
	AHDPBS-016-1805	Shell Size 18, Backshell, Conduit, Snap Over, Straight 180°, Duramate™ AHDP Note: For use with Wide Thread Adapter (WTA). May also be used on DuraMate™ AHDM with P/N AHDM-BS-18NUT Adapter
	AHDPBS-16L017-1805	Shell Size 18, Backshell, Conduit, Snap-Over, Straight, Duramate™ AHDP Note: For use with Backshell Ring Adapter (BRA)
	AHDPBS-010-2405	Shell Size 24, Backshell, Conduit, Snap Over, Straight 180°, Duramate™ AHDP Note: For use with Wide Thread Adapter (WTA). May also be used on DuraMate™ AHDM with P/N AHDM-BS-24NUT Adapter
	AHDPBS-10L017-2405	Shell Size 24, Backshell, Conduit, Snap-Over, Straight, Duramate™ AHDP Note: For use with Backshell Ring Adapter (BRA) and Small Thread Adapter (STA)
	AHDPBS-18-001	Shell Size 18, Backshell, Tie Wrap, Wide Thread Adapter (WTA), Cable Dia. 14.5mm - 18.0mm, Duramate™ AHDP Note: For use with Wide Thread Adapter (WTA)
	AHDPBS-0406-001	Shell Size 24, Backshell, Tie Wrap, Wide Thread Adapter (WTA), Duramate™ AHDP Note: For use with Wide Thread Adapter (WTA)
	AHDPBS-18-002	Shell Size 18, Backshell, Wide Thread Adapter (WTA), 2PC, Compression Nut, Cable Dia. 14.5mm-18.0mm, Duramate™ AHDP Note: For use with Wide Thread Adapter (WTA)
	AHDPBS-24L015-005	Shell Size 24, Backshell, Small Thread Adapter (STA), 2 PC, Compression Nut, Cable Dia. 14.5mm - 18.0mm, Duramate™ AHDP Note: For use with Small Thread Adapter (STA)
	AHDPBS-0406-002	Shell Size 24, Backshell, Wide Thread Adapter (WTA), 2 PC, Compression Nut, Cable Dia. 14.5mm - 18.0mm, Duramate™ AHDP Note: For use with Wide Thread Adapter (WTA)
	AHDPBS-0406-003	Shell Size 24, Backshell, Wide Thread Adapter (WTA), 2 PC, Compression Nut, Cable Dia. 19.5mm - 24.1mm, Duramate™ AHDP Note: For use with Wide Thread Adapter (WTA)
	AHDPBS-18-SM01	Shell Size 18, Backshell, Sealed, Cable Grommet, Duramate™ AHDP Note: For use with Wide Thread Adapter (WTA)
	AHDPBS-0406-SM01	Shell Size 24, Backshell, Sealed, Cable Grommet, Duramate™ AHDP Note: For use with Wide Thread Adapter (WTA)
	AHDPM18-BT	Shell Size 18, Rubber Boot, for DuraMate AHDP (SRA only) & AHDM, Plasticsol, Grey Color
	AHDPM18-BT-BK	Shell Size 18, Rubber Boot, for DuraMate AHDP (SRA only) & AHDM, Plasticsol, Black Color
	AHDPM24-BT	Shell Size 24, Rubber Boot, for DuraMate AHDP (SRA only) & AHDM, Plasticsol, Grey Color
	AHDPM24-BT-BK	Shell Size 24, Rubber Boot, for DuraMate AHDP (SRA only) & AHDM, Plasticsol, Black Color
	AHDC06-18	Shell Size 18, Receptacle Cap, Sealed, Duramate™ AHDP
	AHDC06-24	Shell Size 24, Receptacle Cap, Sealed, Duramate™ AHDP
	AHDC04-18	Shell Size 18, Plug Cap, Sealed, Duramate™ AHDP
	AHDC04-24	Shell Size 24, Plug Cap, Sealed, Duramate™ AHDP
	AHDC04-24-PM	Shell Size 24, Plug Cap, Sealed, Threaded, Duramate™ AHDP
	AHDC04-24-PMT	Shell Size 24, Plug Cap, w Tether, Threaded, Lock Washer, Sealed, Duramate™ AHDP
	AHDC04-18-T	Shell Size 18, Plug Cap, w Tether, Sealed, Duramate™ AHDP
	AHDC04-24-T	Shell Size 24, Plug Cap, w Tether, Sealed, Duramate™ AHDP

Image	Part Number	Description
	AHDPSCC-24	Shell Size 24, Self-Closing Protective Cap, DuraMate™ AHDP / DuraMate™ AHDP ISOBUS 91 Series, Black
	AHDP18-PN01	Shell Size 18, Panel Nut, DuraMate™ AHDP
	AHDP24-PN01	Shell Size 24, Panel Nut, Duramate™ AHDP
	AT14-002-1886	Shell Size 18, Lock Washer, Wave, DuraMate™ AHDP
	AT14-001-2486	Shell Size 24, Lock Washer, Wave, Duramate™ AHDP
	AHDP-16-04978	Shell Size 18, Rubber Flange Seal, Duramate™ AHDP/ Duramate™ AHDM
	AHDP-16-04477	Shell Size 24, Rubber Flange Seal, Duramate™ AHDP/ Duramate™ AHDM
	A114019	Contact Size 4, Blank Seal Plug
	A114018	Contact Size 8, Blank Seal Plug
	A114017	Contact Size 12/16, Blank Seal Plug
	AT13-217-1605	Contact Size 16, Locking Seal Plug
	AT13-204-2005	Contact Size 20, Blank Seal Plug
	AT11-027-0405	Contact Size 4+, Contact Removal Tool, 4AWG
	AT114009	Contact Size 4, Contact Removal Tool, 6AWG
	AT11-001-3.6M	Contact Size 8, Contact Removal Tool, 7-10AWG
	AT114008	Contact Size 8, Contact Removal Tool, 8-10AWG
	AT11-337-1205	Contact Size 12, Contact Removal Tool, 12-14AWG
	AT11-310-1605	Contact Size 16, Contact Removal Tool, 16-20AWG
	AT11-240-2005	Contact Size 20, Contact Removal Tool, 20-22AWG



DM DuraMate™ AHDP with HYPERBUSS™



DuraMate™ AHDP Bussed Receptacles

Available in 16 position

Amphenol Sine Systems' **DuraMate™ AHDP with HYPERBUSS™ Bussed Receptacles** are an environmentally-sealed, multi-pin, heavy duty, plastic, circular connector for use in applications where a common "bussed" electrical pathway is required, such as Bussed Feedback Receptacles used as a Splice Block or Tap Block. IP68 and IP69K rated (in mated condition), the DuraMate™ AHDP with HYPERBUSS™ Bussed Receptacles contain an economical, quick-connect, circular, bayonet locking system to ensure proper mating with standard DuraMate™ AHDP plugs, as well as industry standard connectors,

Buss: a conductor, or a group of conductors, used for collecting electric power from the incoming feeders and distributes them to the outgoing feeders; a type of electrical junction in which all the incoming and outgoing electrical current meets.

Key Features

- Includes Bolt, Nut and Washers
- Available in Power (Red) or Ground (Black)
- Sealed (potted) Intergrated Bussed Feedback Assembly
- IP68 and IP69K rated (in mated condition)
- Quick-connect, circular, bayonet coupling system
- Intermateable with standard DuraMate™ AHDP plugs



Applications: Heavy Duty, Transportation, Marine, Military, Alternative Energy, Agricultural and other interconnect

DuraMate™ AHDP with HYPERBUSS™ - Specifications (Ref Individual Datasheets)

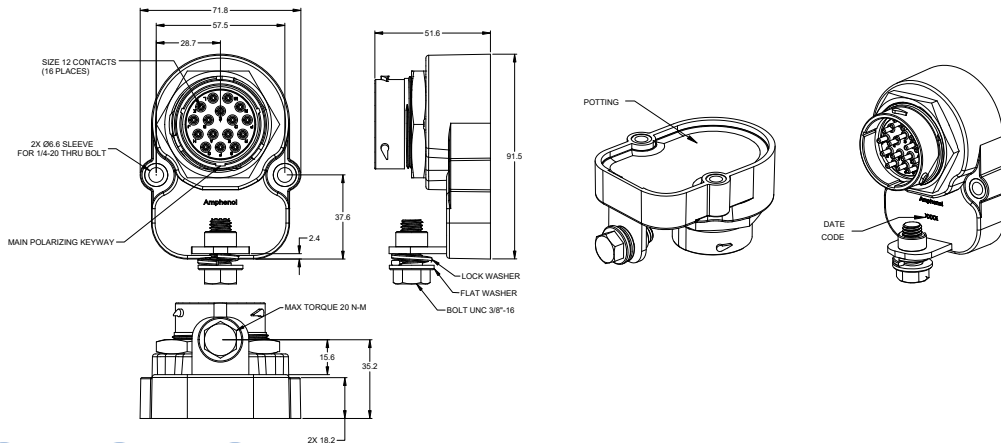

IP Rating (in mated condition)	IP68 and IP69K	Contact Material	Copper Alloy, Nickel Plated
Contact Size	12	Bracket	Copper Alloy, Nickel Plated
Max. Current (Amperage)	25A Each (400A Max)	Sleeves	Aluminum, Black Anodized
Operating Temperature	-55°C to +125°C	Min. Mating Cycles	>100
Coupling System	Quick-Connect, Circular Bayonet	RoHS Compliant	ALL materials meet the requirements of the European Directive. (See website for documentation)
Housing Body	Thermoplastic	Approvals	-
Contact Types	Machined		

DuraMate™ AHDP with HYPERBUSS™ - 16 Position Bussed Receptacle Dimensions (mm)



Standard products. Custom solutions
Customer Service +1 800 394 7732

DuraMate™ AHDP with HYPERBUSST™ - 16 Position Bussed Receptacles [For intermateable DuraMate™ AHDP Series plugs \(AHDP06-\), refer to our website](#)

Image	Pin Layout/Image	Part Number	Description	Contact Size	Amperage
		AHDPH04-24-16P-BLK-CN	Shell Size 24, 16 Position, Receptacle, Size 12 Contacts, (1) 16 Pin (400A), DuraMate™ AHDP with HYPERBUSST™, Plastic, Potted, Black Body (Includes bolt, nut and washers)	12	25A (400A Max)
		AHDPH04-24-16P-RED-CN	Shell Size 24, 16 Position, Receptacle, Size 12 Contacts, (1) 16 Pin (400A), DuraMate™ AHDP with HYPERBUSST™, Plastic, Potted, Red Body (Includes bolt, nut and washers)	12	25A (400A Max)



DM DuraMate™ AHDP ISOBUS 91 Series

Environmentally-Sealed, Multi-Pin, Heavy-Duty, Plastic Circular ISOBUS Connectors



Available in Shell Size 24, 9 Position

Amphenol Sine Systems' **DuraMate™ AHDP ISOBUS 91 Series** connectors are an environmentally-sealed, multi-pin, heavy duty, plastic, circular connector with IP68 and IP69K ratings (in mated condition) that contains an economical, quick-connect, bayonet locking system manufactured to withstand the challenges and complexities of harsh environment, off-road applications. *The DuraMate™ AHDP ISOBUS 91 Series is specifically designed to meet ISO 11783 standards (for control and communications between tractors, implements and software) and withstand the challenges and complexities of harsh environment, off-road, agricultural applications.*

Key ISOBUS 91 Series Features

- + One-to-one alternative for all HDP20 parts
- + Compatible to other industry standard circular bayonet versions
- + AHDP 91 Series Plugs have a jumper (bridged contacts) between Pin 4 & 5. (-P064 options have no jumper (bridged contacts) between Pin 4 & 5.)
- + AHDP 91 Series Receptacles do not have a jumper (bridged contact)
- + Options for up to 6AWG/16mm² power wires
- + Full range of backshell options

Key DuraMate™ Features

- 3 key-way bayonet design ensures proper mating of connectors
- High density signal and mixed power insert configurations
- Operating temperature range: -55°C to +125°C
- High-strength, impact resistant & lightweight thermoplastic housings
- Low-insertion force stamped terminals offer improved manufacturing efficiencies
- Environmentally-sealed and engineered rapid and secure mating system achieves up to IP69K rating (in mated condition) from ingress of dust, water, mud and other contaminants and is vibration resistant
- Sealing features consisting of durable high-temperature silicone provide barrier from lubricating oils, hydraulic fluids and fossil fuels
- Backshells maintain a compression-fit design to resist maximum pull-out forces and facilitate strain-relief for jacketed cable ranges
- Wire entry sealing available in four separate ranges for discrete wire applications
- Smooth Ring Adapters (SRA) are designed for use without backshells for a smaller footprint
- Small Thread Adapters (STA) provide an enhanced "step down" threading for use with screw-on or clamshell backshells
- Wide Thread Adapters (WTA) provide an enhanced threading for use with our wide variety of screw-on or clamshell backshells
- Utilizes A Series™ standard contact system (Stamped & Formed or Machined)



DuraMate™ AHDP ISOBUS 91 Series - Specifications (Ref. Individual Datasheets)

Current Rating per Contact	Size 8, 60A Size 12, 25A Size 16, 13A
Operating Temperature	-55°C to +125°C
Dielectric Withstanding Voltage	Current Leakage -2mA at 1500 VAC
IP Rating (in mated condition)	IP68 and IP69K
Mating Cycle Durability	100 Cycles

Housing Material	Thermoplastic
Insulation Insert	Thermoplastic
Seal	Silicone Rubber
Contact	A Series™ Common System
RoHS Compliant	ALL materials meet the requirements of the European Directive. (See website for documentation)



Standard products. Custom solutions
Customer Service +1 800 394 7732

DuraMate™ AHDP ISOBUS 91 Series - Insert Arrangements

Shell Size 24	Contact Legend (Size/Amp)			
24-91 2 x Size 8, 2 x Size 12, 5 x Size 16				
	Size 8 (6AWG) 60A	Size 8 (8-10AWG) 60A	Size 12 25A	Size 16 13A
N	R			

DuraMate™ AHDP ISOBUS 91 Series - Recommended Wire Insulation Overall Diameter (OD)

Contact Size	Typical Wire Range	(N) Normal Seal	(R) Reduced Seal	(R) Reduced Seal for 6AWG/16mm ² (Size 8 Contacts Only)
8	6-10AWG (5.0-16.0mm ²)	4.83-6.10mm (0.190-0.240")	3.43-5.59mm (0.135-0.220")	6.50-7.42mm (0.256-0.292")
12	10-14AWG (6.0-2.0mm ²)	3.40-4.32mm (0.134-0.170")	2.46-4.01mm (0.135-0.158")	2.46-4.01mm (0.135-0.158")
16	14-20AWG (2.0-0.5mm ²)	2.54-3.40mm (0.100-0.134")	1.35-3.05mm (0.053-0.120")	1.35-3.05mm (0.053-0.120")z

DuraMate™ AHDP ISOBUS 91 Series - Backshell Options and Accessory Overview



DuraMate™ AHDP ISOBUS 91 Series - Plug & Receptacle Options (Dimensions in mm)

Shell Size 24 Plug	Shell Size 24 Receptacle	Shell Size 24 Plug	Shell Size 24 Receptacle
<p>Smooth Ring Adapter (SRA)</p>	<p>Smooth Ring Adapter (SRA)</p>	<p>Small Thread Adapter (STA)</p>	<p>Small Thread Adapter (STA)</p>
<p>Wide Thread Adapter (WTA)</p>	<p>Wide Thread Adapter (WTA)</p>		

DuraMate™ AHDP ISOBUS 91 Series - Plugs

Image	Part Number	Description	Contact Size/Amp	Voltage
	AHDP06-24-91SN-SRA	Shell Size 24, 9 Position, Plug, Socket, DuraMate™ AHDP ISOBUS 91 Series, Plastic, Normal Diameter Seal (Green), Smooth Ring Adapter (SRA)	Size 8, 60A Size 12, 25A Size 16, 13A	250V
	AHDP06-24-91SN-STA	Shell Size 24, 9 Position, Plug, Socket, DuraMate™ AHDP ISOBUS 91 Series, Plastic, Normal Diameter Seal (Green), Small Thread Adapter (STA)	Size 8, 60A Size 12, 25A Size 16, 13A	250V
	AHDP06-24-91SN-WTA	Shell Size 24, 9 Position, Plug, Socket, DuraMate™ AHDP ISOBUS 91 Series, Plastic, Normal Diameter Seal (Green), Wide Thread Adapter (WTA)	Size 8, 60A Size 12, 25A Size 16, 13A	250V
	AHDP06-24-91SR-SRA	Shell Size 24, 9 Position, Plug, Socket, DuraMate™ AHDP ISOBUS 91 Series, Plastic, Reduced Diameter Seal (Blue), Smooth Ring Adapter (SRA)	Size 8, 60A Size 12, 25A Size 16, 13A	250V
	AHDP06-24-91SR-STA	Shell Size 24, 9 Position, Plug, Socket, DuraMate™ AHDP ISOBUS 91 Series, Plastic, Reduced Diameter Seal (Blue), Small Thread Adapter (STA)	Size 8, 60A Size 12, 25A Size 16, 13A	250V
	AHDP06-24-91SR-WTA	Shell Size 24, 9 Position, Plug, Socket, DuraMate™ AHDP ISOBUS 91 Series, Plastic, Reduced Diameter Seal (Blue), Wide Thread Adapter (WTA)	Size 8, 60A Size 12, 25A Size 16, 13A	250V
	AHDP06-24-91SR16-SRA	Shell Size 24, 9 Position, Plug, Socket, DuraMate™ AHDP ISOBUS 91 Series, Plastic, Reduced Diameter Seal (Blue), Smooth Ring Adapter (SRA), Size 8 Contact, 6AWG/1.6mm² Wire Seal Note: Use AT62-203-08141-16 contacts for 6AWG/1.6mm² applications	Size 8, 60A Size 12, 25A Size 16, 13A	250V
	AHDP06-24-91SR16-STA	Shell Size 24, 9 Position, Plug, Socket, DuraMate™ AHDP ISOBUS 91 Series, Plastic, Reduced Diameter Seal, Small Thread Adapter STA (Blue), Size 8 Contact, 6AWG/1.6mm² Wire Seal	Size 8, 60A Size 12, 25A Size 16, 13A	250V
	AHDP06-24-91SR16-WTA	Shell Size 24, 9 Position, Plug, Socket, DuraMate™ AHDP ISOBUS 91 Series, Plastic, Reduced Diameter Seal (Blue), Wide Thread Adapter (WTA), Size 8 Contact, 6AWG/1.6mm² Wire Seal Note: Use AT62-203-08141-16 contacts for 6AWG/1.6mm² applications	Size 8, 60A Size 12, 25A Size 16, 13A	250V
	AHDP06-24-91SN-P064	Shell Size 24, 9 Position, Plug, Socket, DuraMate™ AHDP ISOBUS 91 Series, Plastic, Normal Diameter Seal, Smooth Ring Adapter (SRA) (Green) No Jumper (Bridged Contacts) Between Pin 4 & 5	Size 8, 60A Size 12, 25A Size 16, 13A	250V
	AHDP06-24-91SR-P064	Shell Size 24, 9 Position, Plug, Socket, DuraMate™ AHDP ISOBUS 91 Series, Plastic, Reduced Diameter Seal, Smooth Ring Adapter (SRA) (Green) No Jumper (Bridged Contacts) Between Pin 4 & 5	Size 8, 60A Size 12, 25A Size 16, 13A	250V

DuraMate™ AHDP ISOBUS 91 Series - Receptacles









Image	Part Number	Description	Contact Size/Amp	Voltage
	AHDP04-24-91PN-SRA	Shell Size 24, 9 Position, Receptacle, Pin, DuraMate™ AHDP ISOBUS 91 Series, Plastic, Normal Diameter Seal (Green), Smooth Ring Adapter (SRA)	Size 8, 60A Size 12, 25A Size 16, 13A	250V
	AHDP04-24-91PN-STA	Shell Size 24, 9 Position, Receptacle, Pin, DuraMate™ AHDP ISOBUS 91 Series, Plastic, Normal Diameter Seal, Small Thread Adapter STA (Green)	Size 8, 60A Size 12, 25A Size 16, 13A	250V
	AHDP04-24-91PN-WTA	Shell Size 24, 9 Position, Receptacle, Pin, DuraMate™ AHDP ISOBUS 91 Series, Plastic, Normal Diameter Seal (Green), Wide Thread Adapter (WTA)	Size 8, 60A Size 12, 25A Size 16, 13A	250V

Image	Part Number	Description	Contact Size/Amp	Voltage
	AHDP04-24-91PR-SRA	Shell Size 24, 9 Position, Receptacle, Pin, DuraMate™ AHDP ISOBUS 91 Series, Plastic, Reduced Diameter Seal (Blue), Smooth Ring Adapter (SRA)	Size 8, 60A Size 12, 25A Size 16, 13A	250V
	AHDP04-24-91PR-STA	Shell Size 24, 9 Position, Receptacle, Pin, DuraMate™ AHDP ISOBUS 91 Series, Plastic, Reduced Diameter Seal, Small Thread Adapter STA (Blue)	Size 8, 60A Size 12, 25A Size 16, 13A	250V
	AHDP04-24-91PR-WTA	Shell Size 24, 9 Position, Receptacle, Pin, DuraMate™ AHDP ISOBUS 91 Series, Plastic, Reduced Diameter Seal (Blue), Wide Thread Adapter (WTA)	Size 8, 60A Size 12, 25A Size 16, 13A	250V
	AHDP04-24-91PR16-SRA	Shell Size 24, 9 Pos, Receptacle, Pin, DuraMate™ AHDP ISOBUS 91 Series, Plastic, Reduced Diameter Seal (Blue), Smooth Ring Adapter (SRA), Size 8 Contact, 6AWG/16mm² Wire Seal Note: Use AT60-204-08141-16 contacts for 6AWG/16mm² applications	Size 8, 60A Size 12, 25A Size 16, 13A	250V
	AHDP04-24-91PR16-STA	Shell Size 24, 9 Position, Receptacle, Pin, DuraMate™ AHDP ISOBUS 91 Series, Plastic, Reduced Diameter Seal, Small Thread Adapter STA (Blue), Size 8 Contact, 6AWG/16mm² Wire Seal	Size 8, 60A Size 12, 25A Size 16, 13A	250V
	AHDP04-24-91PR16-WTA	Shell Size 24, 9 Position, Receptacle, Pin, DuraMate™ AHDP ISOBUS 91 Series, Plastic, Reduced Diameter Seal (Blue), Wide Thread Adapter (WTA), Size 8 Contact, 6AWG/16mm² Wire Seal Note: Use AT60-204-08141-16 contacts for 6AWG/16mm² applications	Size 8, 60A Size 12, 25A Size 16, 13A	250V

DuraMate™ AHDP ISOBUS 91 Series - Backshell Options and Accessories









Image	Part Number	Description
	AHDPBS-011-2405	Shell Size 24, Backshell, Conduit, Snap Over, Right Angle 90°, DuraMate™ AHDP ISOBUS 91 Series Note: For use with Wide Thread Adapter (WTA). May also be used on DuraMate™ AHDM with P/N AHDM-BS-24NUT Adapter
	AHDPBS-11L017-2405	Shell Size 24, Backshell, Conduit, Snap-Over, Right Angle 180°, DuraMate™ AHDP Note: For use with Backshell Ring Adapter (BRA) and Small Thread Adapter (STA)
	AHDPBS-010-2405	Shell Size 24, Backshell, Conduit, Snap Over, Straight 180°, DuraMate™ AHDP ISOBUS 91 Series Note: For use with Wide Thread Adapter (WTA). May also be used on DuraMate™ AHDM with P/N AHDM-BS-24NUT Adapter
	AHDPBS-10L017-2405	Shell Size 24, Backshell, Conduit, Snap-Over, Straight, DuraMate™ AHDP Note: For use with Backshell Ring Adapter (BRA) and Small Thread Adapter (STA)
	AHDPBS-0406-001	Shell Size 24, Backshell, Tie Wrap, Wide Thread Adapter (WTA), DuraMate™ AHDP ISOBUS 91 Series Note: For use with Wide Thread Adapter (WTA).
	AHDPBS-0406-002	Shell Size 24, Backshell, Wide Thread Adapter (WTA), 2 PC, Compression Nut, Cable Dia. Range 14.5mm - 18.0mm, DuraMate™ AHDP ISOBUS 91 Series
	AHDPBS-0406-003	Shell Size 24, Backshell, Wide Thread Adapter (WTA), 2 PC, Compression Nut, Cable Dia. Range 19.5mm - 24.1mm, DuraMate™ AHDP ISOBUS 91 Series
	AHDPBS-24L015-005	Shell Size 24, Backshell, Small Thread Adapter (STA), 2 PC, Compression Nut, Cable Dia. Range 14.5mm - 18.0mm, DuraMate™ AHDP Note: For use with Small Thread Adapter (STA)
	AHDPBS-0406-SM01	Shell Size 24, Backshell, Sealed, Cable Grommet, DuraMate™ AHDP ISOBUS 91 Series
	AHDPM18-BT	Shell Size 18, Rubber Boot, for DuraMate AHDP (SRA only) & AHDM, Plasticsol, Grey Color
	AHDPM18-BT-BK	Shell Size 18, Rubber Boot, for DuraMate AHDP (SRA only) & AHDM, Plasticsol, Black Color
	AHDPM24-BT	Shell Size 24, Rubber Boot, for DuraMate AHDP (SRA only) & AHDM, Plasticsol, Grey Color
	AHDPM24-BT-BK	Shell Size 24, Rubber Boot, for DuraMate AHDP (SRA only) & AHDM, Plasticsol, Black Color
	AHDC06-24	Shell Size 24, Receptacle Cap, Sealed, DuraMate™ AHDP ISOBUS 91 Series
	AHDC04-24-PM	Shell Size 24, Plug Cap, Sealed, Threaded, DuraMate™ AHDP ISOBUS 91 Series

Image	Part Number	Description
	AHDC04-24-PMT	Shell Size 24, Plug Cap, w Tether, Threaded, Lock Washer, Sealed, DuraMate™ AHDP ISOBUS 91 Series
	AHDPSCC-24	Shell Size 24, Self-Closing Protective Cap, DuraMate™ AHDP / DuraMate™ AHDP ISOBUS 91 Series, Black
	AHDP24-PN01	Shell Size 24, Panel Nut, DuraMate™ AHDP ISOBUS 91 Series
	AT14-001-2486	Shell Size 24, Lock Washer, Wave, DuraMate™ AHDP ISOBUS 91 Series
	AHDP-16-04477	Shell Size 24, Rubber Flange Seal, Duramate™ AHDP/ Duramate™ AHDM/AHDP ISOBUS 91 Series
	A114018	Contact Size 8, Blank Seal Plug
	A114017	Contact Size 12/16, Blank Seal Plug
	AT13-217-1605	Contact Size 16, Locking Seal Plug
	AT11-310-1605	Contact Size 16, Contact Removal Tool, Light Blue, 16-20AWG
	AT11-337-1205	Contact Size 12, Contact Removal Tool, Orange, 12-14AWG
	AT11-001-3.6M	Contact Size 8, Contact Removal Tool, Black, 7-10AWG
	AT114008	Contact Size 8, Contact Removal Tool, Green, 8-10AWG
	AT60-204-08141-16	Contact Size 8, 6AWG/16mm² Wire Range, Contact, Pin, Nickel-plated Note: Refer to Plug/Receptacle datasheets for a complete list of available contacts
	AT62-203-08141-16	Contact Size 8, 6AWG/16mm² Wire Range, Contact, Socket, Nickel-plated Note: Refer to Plug/Receptacle datasheets for a complete list of available contacts



DM Dura|Mate™ AHDM

Environmentally-Sealed, Multi-Pin, Heavy-Duty, Metal, Circular Connectors



Available in Shell Size 18 with 6 insert arrangements 2, 6, 8, 14, 20 and 21

Available in Shell Size 24 with 15 insert arrangements 7(x2), 9, 14, 16, 18, 19, 21, 23, 27, 29, 31, 33, 35 and 47

Amphenol Sine Systems' DuraMate™ AHDM connectors are an environmentally-sealed, multi-pin, heavy duty, metal, circular connector with IP68 and IP69K ratings (in mated condition) that contains an economical, quick-connect, bayonet locking system manufactured to withstand the challenges and complexities of harsh environment off-road applications. Available in the following options: DuraMate™ AHDM/AHDBM ISOBUS 91 Series.

DM Dura|Mate™ AHDM/AHDBM ISOBUS 91 Series

Key Features

- 3 key-way bayonet design ensures proper mating of connectors
- High density signal and mixed power insert configurations
- Operating temperature range: -55°C to +125°C
- High current configurations incorporating revolutionary RADSOK® contacts
- High strength impact resistant & lightweight zinc-alloy metal housings
- Low insertion force stamped terminals offer improved manufacturing efficiencies
- Environmentally-sealed and engineered rapid and secure mating system achieves up to IP69K rating (in mated condition) from ingress of dust, water, mud and other contaminants and is vibration resistant
- Sealing features consisting of durable high temperature silicone provide barrier from lubricating oils, hydraulic fluids and fossil fuels
- Backshells maintain a compression-fit design to resist maximum pull-out forces and facilitate strain-relief for jacketed cable ranges.
- Utilizes A Series™ standard contact system (Stamped & Formed or Machined)
- Wire entry sealing available in three separate ranges for discrete wire applications
- Integrated Wide Threading provides an enhanced threading for use with our wide variety of screw-on or clamshell backshells
- Utilizes A Series™ standard contact system (Stamped & Formed or Machined)



DuraMate™ AHDM - Specifications (Reference Individual Datasheets)

Current Rating per Contact	Size 4 - 100A / Size 4+ - 100A Size 8 - 60A / Size 8 RADSOK - 80A Size 12 - 25A Size 16 - 13A Size 20 - 7.5A
Operating Temperature	-55°C to +125°C
Dielectric Withstanding Voltage	Current Leakage -2mA at 1500 VAC
IP Rating (in mated condition)	IP68 and IP69K
Mating Cycle Durability	100 Cycles

Housing Material	Zinc-Alloy
Insulation Insert	Thermoplastic
Seal	Silicone Rubber
Contact	A Series™ Common System
RoHS Compliant	ALL materials meet the requirements of the European Directive. (See website for documentation)



Standard products. Custom solutions
Customer Service +1 800 394 7732

DuraMate™ AHDM - Insert Arrangements (1) C030 - 6 Position/2 Used (Size 4); (4) CL22 - 7 Position Alt Construction)

Shell Size 18					
18-06 (1) 2 x Size 4	18-06 2 x Size 4, 4 x Size 16	18-08 8 x Size 12	18-14 14 x Size 16	18-20 2 x Size 16, 18 x Size 20	18-21 21 x Size 20
N	N	N	R	N	R

Contact Legend (Size/Amp)					
Size 4 or 4+ 100A	Size 8 60A	Size 8 RADSOK® 80A	Size 12 25A	Size 16 13A	Size 20 7.5A

Shell Size 24									
24-07 1 X Size 8 (RADSOK®) 6 X Size 12	24-07 (4) 3 X Size 4, 4 X Size 16	24-09 1 X Size 4, 2 X Size 8 6 X Size 12	24-14 1 X Size 4, 1 X Size 12 12 X Size 16	24-16 16 X Size 12	24-18 1 X Size 8, 3 X Size 12 14 X Size 16	24-19 6 X Size 12, 13 X Size 16	24-21 4 X Size 12, 17 X Size 16	24-23 23 X Size 16	24-27 4 X Size 12, 23 X Size 16
N	N	N	R	N	R	N	R	N	T

Shell Size 24				
24-29 4 X Size 12, 19 X Size 16 6 X Size 20	24-31 31 X Size 16	24-33 33 X Size 20	24-35 3 X Size 16, 32 X Size 20	24-47 5 X Size 16, 42 X Size 20
R	R	T	N	R







DuraMate™ AHDM - Recommended Wire Insulation Overall Diameter (OD) 4+ contact is only available for 24-07CL22

Contact Size	Typical Wire Range	(N) Normal Seal	(T) Thin Seal	(R) Reduced Seal (See datasheets)	
4+	4AWG (25.0-21.0mm²)	7.9-10.67mm (0.311-0.420")	-	-	-
4	6AWG (16.0-13.0mm²)	6.63-7.41mm (0.261-0.292")	-	6.63-7.41mm (0.261-0.292")	-
8	8-10AWG (10.0-5.0mm²)	4.83-6.10mm (0.190-0.240")	-	3.43-5.59mm (0.135-0.220")	-
12	10-14AWG (6.0-2.0mm²)	3.43-4.32mm (0.1350-.170")	-	2.46-4.01mm (0.135-0.158")	2.46-4.01mm (0.135-0.158")
16	14-20AWG (2.0-0.5mm²)	2.54-3.40mm (0.100-0.134")	2.23-2.69mm (0.088-.106")	1.35-3.05mm(0.053-0.120")	1.35-2.62mm (0.053-0.103")
20	16-22AWG (1.5-0.35mm²)	1.02-2.41mm (0.040-.095")	-	1.02-02.41mm (0.040-0.095")	1.02-2.10mm (0.040-0.083")

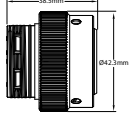
DuraMate™ AHDM - Backshell Options and Accessory Overview

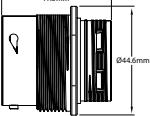

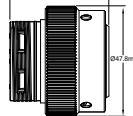
DuraMate™ AHDM - Plug & Receptacle Options (Dimensions in mm)

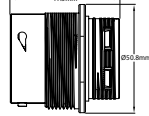
Shell Size 18 Plug		Shell Size 18 Receptacle		Shell Size 24 Plug		Shell Size 24 Receptacle	
Integrated Wide Threading		Integrated Wide Threading		Integrated Wide Threading		Integrated Wide Threading	
							

DuraMate™ AHDM - Backshell Options and Accessories





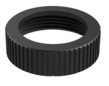









Image	Part Number	Description
	AHDMBS-24-002	Shell Size 24, Backshell, 2 PC, DuraMate™ AHDM
	AHDMBS-18-002	Shell Size 18, Backshell, 2 PC, DuraMate™ AHDM
	AHDMBS-24-001	Shell Size 24, Backshell, Tie Wrap, End Bell, DuraMate™ AHDM
	AHDMBS-18-001	Shell Size 18, Backshell, Tie Wrap, End Bell, DuraMate™ AHDM
	AHDMBS-24-059	Shell Size 24, Backshell, w Cable Clamp, DuraMate™ AHDM
	AHDMBS-18-059	Shell Size 18, Backshell, w Cable Clamp, DuraMate™ AHDM
	AHDMBS-24-SM01	Shell Size 24, Backshell, Metal, DuraMate™ AHDM
	AHDMBS-18-SM01	Size 18, Backshell, Metal, DuraMate™ AHDM
	AHDPM18-BT	Shell Size 18, Rubber Boot, for DuraMate AHDP (SRA only) & AHDM, Plastisol, Grey Color
	AHDPM18-BT-BK	Shell Size 18, Rubber Boot, for DuraMate AHDP (SRA only) & AHDM, Plastisol, Black Color
	AHDPM24-BT	Shell Size 24, Rubber Boot, for DuraMate AHDP (SRA only) & AHDM, Plastisol, Grey Color
	AHDPM24-BT-BK	Shell Size 24, Rubber Boot, for DuraMate AHDP (SRA only) & AHDM, Plastisol, Black Color
	AHDM-BS-24NUT	Shell Size 24, Adapter for use with: AHPBS-010-2405 AHDP Backshell, Conduit, Snap-Over, Straight 180 AHPBS-011-2405 AHDP Backshell, Conduit, Snap-Over, Right Angle 90
	AHDM-BS-18NUT	Shell Size 18, Adapter for use with: AHPBS-015-1805 AHDP Backshell, Conduit, Snap-Over, Straight 180 AHPBS-016-1805 AHDP Backshell, Conduit, Snap-Over, Right Angle 90
	AHDC34-24	Shell Size 24, Protective Cap for Plug, DuraMate™ AHDM
	AHDC34-18	Shell Size 18, Protective Cap for Plug, DuraMate™ AHDM
	AHDC36-24	Shell Size 24, Protective Cap for Receptacle, DuraMate™ AHDM
	AHDC36-18	Shell Size 18, Protective Cap for Receptacle, DuraMate™ AHDM

Image	Part Number	Description
	A112264	Shell Size 24, Lockwasher, DuraMate™ AHDM
	A114021	Shell Size 18, Lockwasher, DuraMate™ AHDM
	A112263-90	Shell Size 24, Nut, DuraMate™ AHDM
	A114020-90	Shell Size 18, Nut, DuraMate™ AHDM
	AHDP-16-04477	Shell Size 24, Rubber Flange Seal, Duramate™ AHDP/ Duramate™ AHDM
	AHDP-16-04978	Shell Size 18, Rubber Flange Seal, Duramate™ AHDP/ Duramate™ AHDM
	A114019	Contact Size 4, Blank Seal Plug
	A114018	Contact Size 8, Blank Seal Plug
	A114017	Contact Size 12/16, Blank Seal Plug
	AT13-217-1605	Contact Size 16, Locking Seal Plug
	AT13-204-2005	Contact Size 20, Blank Seal Plug
	AT11-027-0405	Contact Size 4+, Contact Removal Tool, 4AWG
	AT114009	Contact Size 4, Contact Removal Tool, 6AWG
	AT11-001-3.6M	Contact Size 8, Contact Removal Tool, 7-10AWG
	AT114008	Contact Size 8, Contact Removal Tool, 8-10AWG
	AT11-337-1205	Contact Size 12, Contact Removal Tool, 12-14AWG
	AT11-310-1605	Contact Size 16, Contact Removal Tool, 16-20AWG
	AT11-240-2005	Contact Size 20, Contact Removal Tool, 20-22AWG



DM DuraMate™ AHDM/AHDBM ISOBUS 91 Series

Environmentally-Sealed, Multi-Pin, Heavy-Duty, Metal Circular ISOBUS Connectors

Available in Shell Size 24, 9 Position

Amphenol Sine Systems' **DuraMate™ AHDM/AHDBM ISOBUS 91 Series** connectors are an environmentally-sealed, multi-pin, heavy duty, metal, circular connector with IP68 and IP69K ratings (in mated condition) that contains an economical, quick-connect, bayonet locking system manufactured to withstand the challenges and complexities of harsh environment, off-road applications. *The DuraMate™ AHDM/AHDBM ISOBUS 91 Series is specifically designed to meet ISO 11783 standards (for control and communications between tractors, implements and software) and withstand the challenges and complexities of harsh environment, off-road, agricultural applications.*

AHDBM Circular Bayonet Breakaway-Ready Receptacle



AHDM Circular Bayonet Standard Plug

AHDBM Circular Bayonet Breakaway Plug

Important

- AHDBM 91 Series Plugs are intermateable to other industry standard 91 versions and allow full breakaway functionality if used with suitable breakaway-ready Receptacles (like AHDBM 91 Receptacles)
- AHDM 91 Series Plugs are intermateable to other industry standard versions but do not retain breakaway functionality
- AHDBM 91 Series Receptacles (Circular Bayonet) are intermateable to other industry standard plugs and allow breakaway functionality when used with a breakaway Plugs (like AHDBM 91 Plugs)
- Available upon request and not shown on this flyer: AHDM 91 Series Receptacles (Drop Shaped Bayonet) are not intermateable to all industry standard versions and do not retain breakaway functionality

Key ISOBUS 91 Series Features

- + **One-to-one alternative for all HD30/HDB36 parts**
- + **Compatible to other industry standard (Circular Bayonet) versions while retaining full breakaway functionality**
- + **AHDM 91 Series Plugs have a jumper (bridged contacts) between Pin 4 & 5**
- + **AHDM/AHDBM 91 Series Receptacles don't have a jumper (bridged contact)**
- + **Options for up to 16mm² power wires**
- + **Full range of backshell options**

DuraMate™ Features

- 3 key-way bayonet design ensures proper mating of connectors
- High density signal and mixed power insert configurations
- Operating temperature range: -55°C to +125°C
- High-strength, impact resistant & lightweight zinc-alloy metal housings
- Low-insertion force stamped terminals offer improved manufacturing efficiencies
- Environmentally-sealed and engineered rapid and secure mating system achieves up to IP69K rating (in mated condition) from ingress of dust, water, mud and other contaminants and is vibration resistant
- Sealing features consisting of durable high-temperature silicone provide barrier from lubricating oils, hydraulic fluids and fossil fuels
- Backshells maintain a compression-fit design to resist maximum pull-out forces and facilitate strain-relief for jacketed cable ranges
- Wire entry sealing available in four separate ranges for discrete wire applications
- Integrated Wide Threading provides an enhanced threading for use with our wide variety of screw-on or clamshell backshells
- Utilizes A Series™ standard contact system (Stamped & Formed or Machined)



Standard products. Custom solutions
Customer Service +1 800 394 7732

DuraMate™ AHDM/AHDBM ISOBUS 91 Series - Specs (Ref. Individual Datasheets)

Current Rating per Contact	Size 8, 60A; Size 12, 25A; Size 16, 13A
Operating Temperature	-55°C to +125°C
Dielectric Withstanding Voltage	Current Leakage-2mA at 1500 VAC
IP Rating (in mated condition)	IP68 and IP69K
Mating Cycle Durability	100 Cycles
Housing Material	Zinc-alloy/Aluminum-alloy

Insulation Insert	Thermoplastic
Seal	Silicone Rubber
Contact	A Series™ Common System
RoHS Compliant	ALL materials meet the requirements of the European Directive. (See website for documentation)

DuraMate™ AHDM/AHDBM ISOBUS 91 Series - Insert Arrangements

Size 24	Contact Legend (Size/Amp)			
24-91 2 x Size 8, 2 x Size 12, 5 x Size 16				
	Size 8 (6AWG) 60A	Size 8 (8-10AWG) 60A	Size 12 25A	Size 16 13A
N R				

DuraMate™ AHDM/AHDBM ISOBUS 91 Series - Recommended Wire Insulation Overall Diameter (OD)

Contact Size	Typical Wire Range	(N) Normal Seal	(R) Reduced Seal	(R) Reduced Seal for 6AWG/16mm ² (Size 8 Contacts Only)
8	6-10AWG (5.0-16.0mm ²)	4.83-6.10mm (0.190-0.240")	3.43-5.59mm (0.135-0.220")	6.50-7.42mm (0.256-0.292")
12	10-14AWG (6.0-2.0mm ²)	3.40-4.32mm (0.134-0.170")	2.46-4.01mm (0.135-0.158")	2.46-4.01mm (0.135-0.158")
16	14-20AWG (2.0-0.5mm ²)	2.54-3.40mm (0.100-0.134")	1.35-3.05mm (0.053-0.120")	1.35-3.05mm (0.053-0.120")





DuraMate™ AHDM/AHDBM ISOBUS 91 Series - Backshell Options and Accessory Overview



DuraMate™ AHDM/AHDBM ISOBUS 91 Series - Plug & Receptacle Options (Dimensions in mm)

Shell Size 24 AHDM Plug	Shell Size 24 AHDBM Breakaway Plug	Shell Size 24 AHDBM Breakaway Receptacle
Integrated Wide Threading	Integrated Wide Threading	Integrated Wide Threading

DuraMate™ AHDM ISOBUS 91 Series - Plugs

Image	Part Number	Description	Contact Size/Amp	Voltage
	AHDM06-24-91SN	Shell Size 24, 9 Position, Plug, Socket, DuraMate™ AHDM ISOBUS 91 Series, Metal, Normal Diameter Seal (Green), Integrated Wide Threading	Size 8, 60A Size 12, 25A Size 16, 13A	250V
	AHDM06-24-91SN-059	Shell Size 24, 9 Position, Kit, Plug, Socket, DuraMate™ AHDM ISOBUS 91 Series, Metal, Normal Diameter Seal (Green), Integrated Wide Threading, Cable Clamp Backshell	Size 8, 60A Size 12, 25A Size 16, 13A	250V
	AHDM06-24-91SR	Shell Size 24, 9 Position, Plug, Socket, DuraMate™ AHDM ISOBUS 91 Series, Metal, Reduced Diameter Seal (Blue), Integrated Wide Threading	Size 8, 60A Size 12, 25A Size 16, 13A	250V
	AHDM06-24-91SR-059	Shell Size 24, 9 Position, Kit, Plug, Socket, DuraMate™ AHDM ISOBUS 91 Series, Metal, Reduced Diameter Seal (Blue), Integrated Wide Threading, Cable Clamp Backshell	Size 8, 60A Size 12, 25A Size 16, 13A	250V
	AHDM06-24-91SR16	Shell Size 24, 9 Position, Plug, Socket, DuraMate™ AHDM ISOBUS 91 Series, Metal, Reduced Diameter Seal (Blue), Integrated Wide Threading, Size 8 Contact, 6AWG/16mm² Wire Seal Note: Use AT62-203-08141-16 contacts for 6AWG/16mm² applications	Size 8, 60A Size 12, 25A Size 16, 13A	250V
	AHDM06-24-91SR16-059	Shell Size 24, 9 Position, Kit, Plug, Socket, DuraMate™ AHDM ISOBUS 91 Series, Metal, Reduced Diameter Seal (Blue), Integrated Wide Threading, Cable Clamp Backshell, Size 8 Contact, 6AWG/16mm² Wire Seal Note: Use AT62-203-08141-16 contacts for 6AWG/16mm² applications	Size 8, 60A Size 12, 25A Size 16, 13A	250V

DuraMate™ AHDBM ISOBUS 91 Series - Breakaway Plugs

Image	Part Number	Description	Contact Size/Amp	Voltage
	AHDBM06-24-91SN	Shell Size 24, 9 Position, Plug, Socket, Shell DuraMate™ AHDBM ISOBUS 91 Series, Metal, Normal Diameter Seal (Green), Integrated Wide Threading, Breakaway-Ready	Size 8, 60A Size 12, 25A Size 16, 13A	250V
	AHDBM06-24-91SN-059	Shell Size 24, 9 Position, Kit, Plug, Socket, Shell DuraMate™ AHDBM ISOBUS 91 Series, Metal, Normal Diameter Seal (Green), Integrated Wide Threading, Cable Clamp Backshell, Breakaway-Ready	Size 8, 60A Size 12, 25A Size 16, 13A	250V
	AHDBM06-24-91SR	Shell Size 24, 9 Position, Plug, Socket, Shell DuraMate™ AHDBM ISOBUS 91 Series, Metal, Reduced Diameter Seal (Blue), Integrated Wide Threading, Breakaway-Ready	Size 8, 60A Size 12, 25A Size 16, 13A	250V
	AHDBM06-24-91SR-059	Shell Size 24, 9 Position, Kit, Plug, Socket, DuraMate™ AHDBM ISOBUS 91 Series, Metal, Reduced Diameter Seal (Blue), Integrated Wide Threading, Cable Clamp Backshell, Breakaway-Ready	Size 8, 60A Size 12, 25A Size 16, 13A	250V
	AHDBM06-24-91SR16	Shell Size 24, 9 Position, Kit, Plug, Socket, DuraMate™ AHDBM ISOBUS 91 Series, Metal, Reduced Diameter Seal (Blue), Integrated Wide Threading, Cable Clamp Backshell, Breakaway, Size 8 Contact, 6AWG/16mm² Wire Seal Note: Use AT62-203-08141-16 contacts for 6AWG/16mm² applications	Size 8, 60A Size 12, 25A Size 16, 13A	250V
	AHDBM06-24-91SR16-059	Shell Size 24, 9 Position, Plug, Socket, DuraMate™ AHDBM ISOBUS 91 Series, Metal, Reduced Diameter Seal (Blue), Integrated Wide Threading, Breakaway, Size 8 Contact, 6AWG/16mm² Wire Seal Note: Use AT62-203-08141-16 contacts for 6AWG/16mm² applications	Size 8, 60A Size 12, 25A Size 16, 13A	250V

DuraMate™ AHDBM ISOBUS 91 Series - Breakaway-Ready Receptacles

Image	Part Number	Description	Contact Size/Amp	Voltage
	AHDBM04-24-91PN	Shell Size 24, 9 Position, Receptacle, Pin, DuraMate™ AHDBM ISOBUS 91 Series, Metal, Normal Diameter Seal (Green), Integrated Wide Threading, Breakway-Ready	Size 8, 60A Size 12, 25A Size 16, 13A	250V
	AHDBM04-24-91PN-059	Shell Size 24, 9 Position, Kit, Receptacle, Pin, DuraMate™ AHDBM ISOBUS 91 Series, Metal, Normal Diameter Seal (Green), Integrated Wide Threading, Cable Clamp Backshell, Breakway-Ready	Size 8, 60A Size 12, 25A Size 16, 13A	250V
	AHDBM04-24-91PR	Shell Size 24, 9 Position, Receptacle, Pin, DuraMate™ AHDBM ISOBUS 91 Series, Metal, Reduced Diameter Seal (Blue), Integrated Wide Threading, Breakway-Ready	Size 8, 60A Size 12, 25A Size 16, 13A	250V
	AHDBM04-24-91PR-059	Shell Size 24, 9 Position, Kit, Receptacle, Pin, DuraMate™ AHDBM ISOBUS 91 Series, Metal, Reduced Diameter Seal (Blue), Integrated Wide Threading, Cable Clamp Backshell, Breakway-Ready	Size 8, 60A Size 12, 25A Size 16, 13A	250V
	AHDBM04-24-91PR16	Shell Size 24, 9 Position, Receptacle, Pin, DuraMate™ AHDBM ISOBUS 91 Series, Metal, Reduced Diameter Seal (Blue), Integrated Wide Threading, Breakway-Ready, Size 8 Contact, 6AWG/16mm² Wire Seal Note: Use AT60-204-08141-16 contacts for 6AWG/16mm² applications	Size 8, 60A Size 12, 25A Size 16, 13A	250V
	AHDBM04-24-91PR16-059	Shell Size 24, 9 Position, Kit, Receptacle, Pin, DuraMate™ AHDBM ISOBUS 91 Series, Metal, Reduced Diameter Seal (Blue), Integrated Wide Threading, Cable Clamp Backshell, Breakway-Ready, Size 8 Contact, 6AWG/16mm² Wire Seal Note: Use AT60-204-08141-16 contacts for 6AWG/16mm² applications	Size 8, 60A Size 12, 25A Size 16, 13A	250V

DuraMate™ AHDM/AHDBM ISOBUS 91 Series - Backshell Options and Accessories







Image	Part Number	Description
	AHDMBS-24-002	Shell Size 24, Backshell, 2 PC, DuraMate™ AHDM/AHDBM ISOBUS 91 Series
	AHDMBS-24-001	Shell Size 24, Backshell, Tie Wrap, End Bell, DuraMate™ AHDM/AHDBM ISOBUS 91 Series
	AHDMBS-24-059	Shell Size 24, Backshell, w Cable Clamp, DuraMate™ AHDM/AHDBM ISOBUS 91 Series
	AHDMBS-24-SM01	Shell Size 24, Backshell, Metal, DuraMate™ AHDM/AHDBM ISOBUS 91 Series
	AHDPM18-BT	Shell Size 18, Rubber Boot, for DuraMate AHDP (SRA only) & AHDM, Plastics, Grey Color
	AHDPM18-BT-BK	Shell Size 18, Rubber Boot, for DuraMate AHDP (SRA only) & AHDM, Plastics, Black Color
	AHDPM24-BT	Shell Size 24, Rubber Boot, for DuraMate AHDP (SRA only) & AHDM, Plastics, Grey Color
	AHDPM24-BT-BK	Shell Size 24, Rubber Boot, for DuraMate AHDP (SRA only) & AHDM, Plastics, Black Color
	AHDM-BS-24NUT	Shell Size 24, Adapter for use with: AHPBS-010-2405 AHDP Backshell, Conduit, Snap-Over, Straight 180 AHPBS-011-2405 AHDP Backshell, Conduit, Snap-Over, Right Angle 90

Image	Part Number	Description
	AHDC34-24	Shell Size 24, Protective Cap for Plug, DuraMate™ AHDM/AHDBM ISOBUS 91 Series
	AHDC36-24	Shell Size 24, Protective Cap for Receptacle, DuraMate™ AHDM/AHDBM ISOBUS 91 Series
	A112264	Shell Size 24, Lockwasher, DuraMate™ AHDM/AHDBM ISOBUS 91 Series
	A112263-90	Shell Size 24, Nut, DuraMate™ AHDM/AHDBM ISOBUS 91 Series
	AHDP-16-04477	Shell Size 24, Rubber Flange Seal, Duramate™ AHDP/ Duramate™ AHDM
	A114017	Contact Size 12/16, Blank Seal Plug
	AT13-217-1605	Contact Size 16, Locking Seal Plug
	AT11-310-1605	Contact Size 16, Contact Removal Tool, Light Blue, 16-20AWG
	AT11-337-1205	Contact Size 12, Contact Removal Tool, Orange, 12-14AWG
	AT11-001-3.6M	Contact Size 8, Contact Removal Tool, Black, 7-10AWG
	AT114008	Contact Size 8, Contact Removal Tool, Green, 8-10AWG
	AT60-204-08141-16	Contact Size 8, 6AWG/16mm ² Wire Range, Contact, Pin, Nickel-plated Note: Refer to Plug/Receptacle datasheets for a complete list of available contacts
	AT62-203-08141-16	Contact Size 8, 6AWG/16mm ² Wire Range, Contact, Socket, Nickel-plated Note: Refer to Plug/Receptacle datasheets for a complete list of available contacts